

Installation guide for Cassius and Rivius Clay Cloaks

The Sandtoft clay cloak system has been specially designed to suit the Cassius and Rivius clay roof tiles and provides a clay finish alternative to plastic dry verge systems.

Components:

Each soaker pack includes the following:

- 6 x Cover Soakers (700mm long)
- 10 x 35mm Stainless steel screw
- 25 x 45mm Stainless steel screw

Note: The clay verge pieces are sold separately, they are handed and one is required per course, per verge.

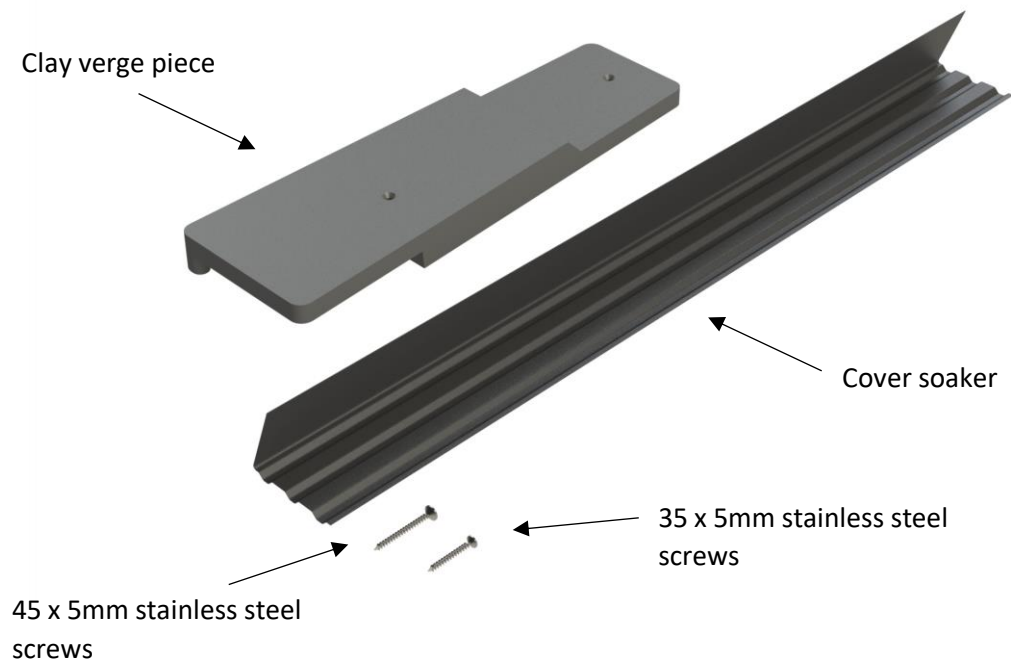

You will need a cross head screwdriver/drill bit to install this system.

Compatibility:

- Cassius
- Rivius

The standard installation details how to install the clay cloaks alongside a bargeboard. For installation without a bargeboard, please refer straight to page 4.

Installation guide for Cassius and Rivius Clay Cloaks

Standard Installation:

1) Carry the underlay approximately 90mm over the outer edge of the wall and then install the tile battens flush with the outer edge of the wall.

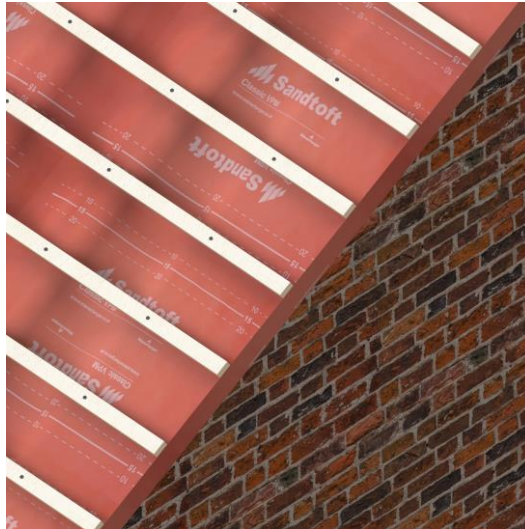

2) Lift the underlay over the tiling battens and install the bargeboard flush with the top face of the tile battens. Drape the underlay back over the bargeboard. The underlay should cover approximately the top 40mm of the bargeboard.

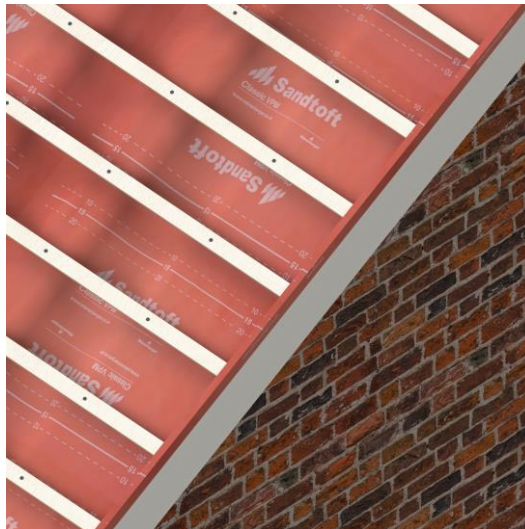

3) Fit the soakers over tiling battens and bargeboard, ensuring each soaker overlaps the next by at least 75mm. Secure using three 20mm aluminium or stainless steel clout head nails per soaker, nailed through the side of the soaker into the bargeboard.

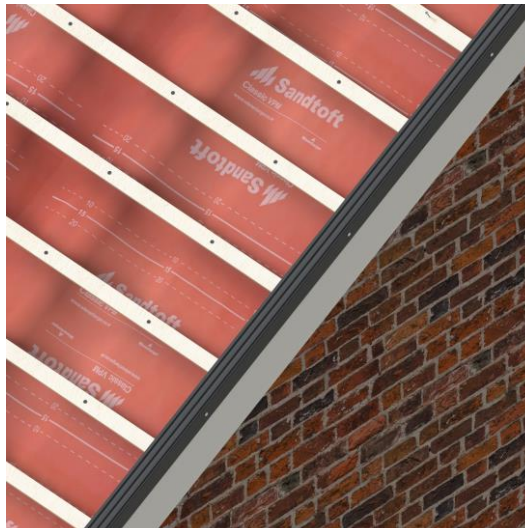

Installation guide for Cassius and Rivius Clay Cloaks

4) Lay the tiles in the usual way, finishing the verge tiles flush with the outer edge of the bargeboard. Fix all verge tiles in accordance with a site specific fixing specification, except where nails are stated use the 45mm screws provided.

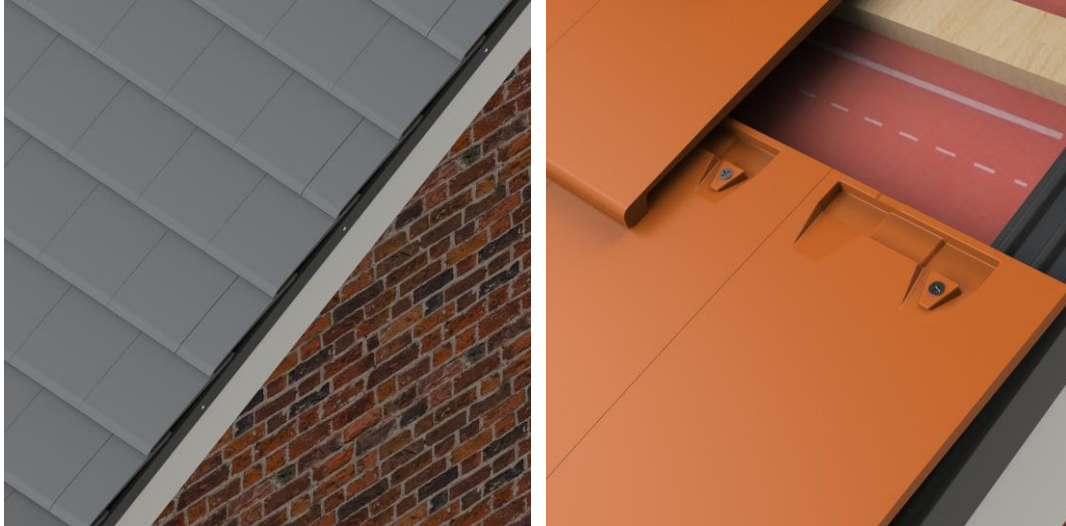

5) Working from the eaves up, fix each cloak flush with the top face of the verge tile. Fix using the 45mm screw provided through the central hole and the 35mm screw provided through the hole at the top of the cloak. Place the next cloak over the cloak below and repeat.



6) With all cloaks installed, neatly seal the gap between each cloak and verge tile using the Sandtoft Multifix adhesive.

Installation guide for Cassius and Rivius Clay Cloaks

Before



After

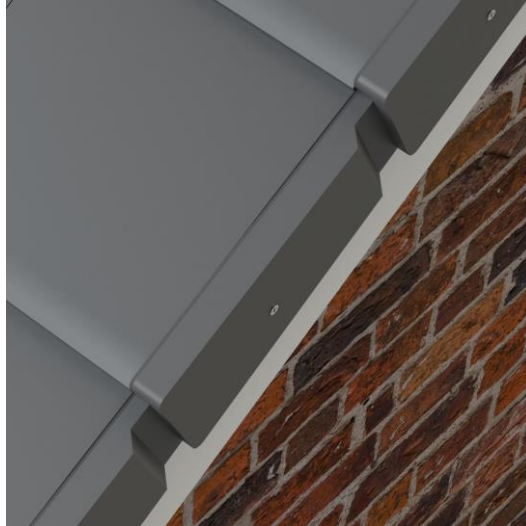

Installation without a bargeboard:

1) Carry the underlay approximately 90mm over the outer edge of the wall and then install the tile battens flush with the outer edge of the wall.

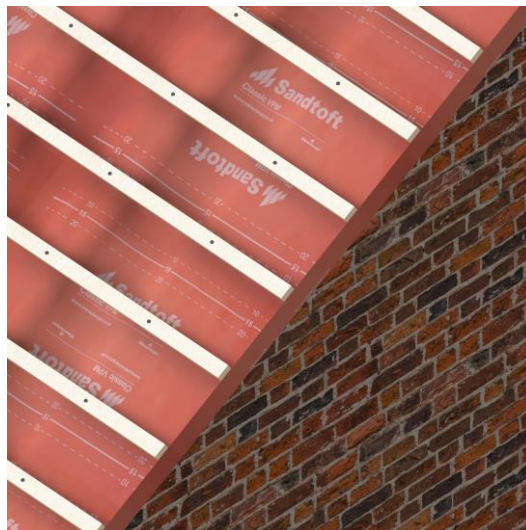

Installation guide for Cassius and Rivius Clay Cloaks

2) Pull the underlay up over the tile battens and install a 50 x 25mm batten, with the 25mm side flush with the top surface of the tile battens. Fix this vertical batten by using screws (not provided) into the end grain of the tile battens.



The alternative work required for installation without a bargeboard is complete, please refer to step 3 of the standard installation to continue.

Technical Enquiries:

Tel: 0844 9395 999
Fax: 0844 9395 950
Email: sandtofttechnical@wienerberger.com

At Wienerberger we are continually innovating and improving our product range. We reserve the right to change product specifications without notice. Please contact our Customer Support Team for the latest information or visit

www.wienerberger.co.uk/technical-hub/rooftiles

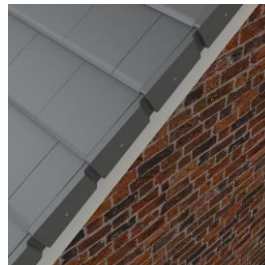

Issue Date: 25/04/2019